

膜片式气泵 Diaphragm Pumps for Gas

DA40AC 系列(Series DA40AC)

特点 Features

无油润滑 Oil-Free
耐腐蚀性 Corrosionresistant
免维护 Maintenance Free
低噪音低振动 Low noise level&vibration
可以任何方向安装 Can be mounted in any plane

结构紧凑 Compact size
长寿命 Long life
重量轻 Low Weight
低功耗 High efficiency
交流电机 AC Motor

应用 Typical Applications

气体采样分析 Gas detection devices
监护仪 Patient Monitoring
血压计 Blood Pressure Monitor
气压按摩 Gas massage products
实验室设备 Lab equipment
洗板设备 Microplate Washer
环境检测 Air Sampler
止血带 Automatic Tourniquet

污水处理 Sewage disposal
喷绘打印 Wide-Format Printer
生化仪 Bio-Chemical Analyzer
电解质 Electrolyte
美容设备 Beauty equipment
化学分析 Chemistry analysis
真空吸取 Vacuum transfer
消毒柜 Autoclave

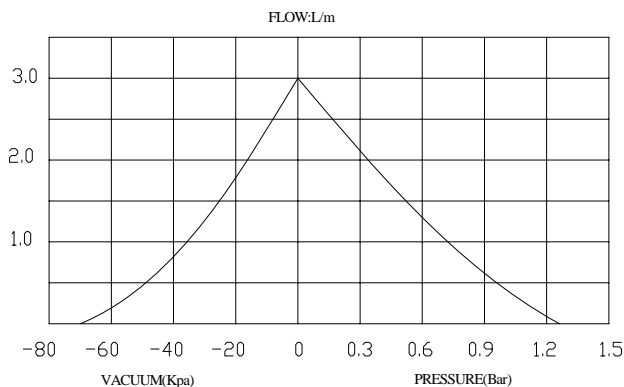

技术参数 Technical Data

额定电压/频率 Voltage/Frequency	AC220V/50Hz	AC110V/60Hz
功率 Power	36W	36W
空载流量 Free flowing	3.0L/M	3.0L/M
最大压力 Max. pressure	1.3Bar	1.3Bar
最大真空度 Max. vacuum	-70Kpa	-70Kpa
使用温度 Ambient temperature	0-40°C	0-40°C
重量 Weight	1.25Kg	1.25Kg
绝 等级 Insulation Class	B	B

- 可以在任何方向安装使用 Can be mounted in any plane
- 真空和压力均可 applicable as vacuum pump or pressure pump

材质: Parts in contact with medium Option

- 泵头Pump head: PA66 or PPS
- 膜片/阀片Diaphragms, valves: EPDM



外形尺寸: Dimensions(mm)

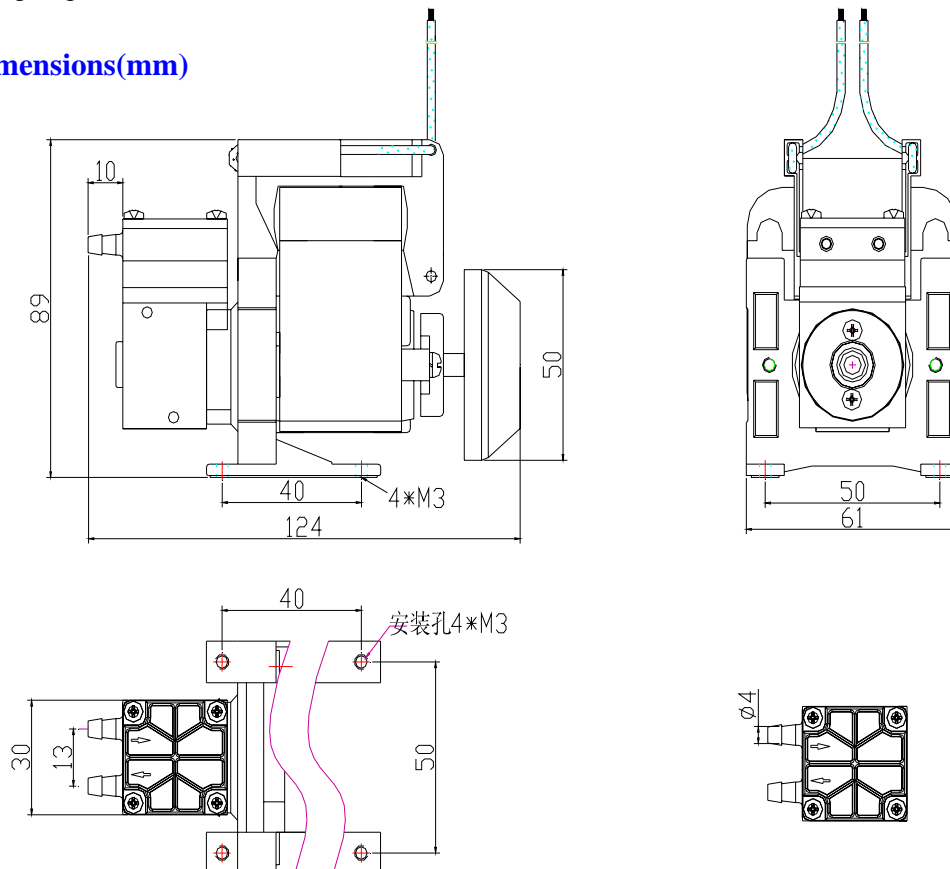

可根据客户使用要求定做: We can design according to customer requirements